

USER MANUAL SLIMLINE

Concept

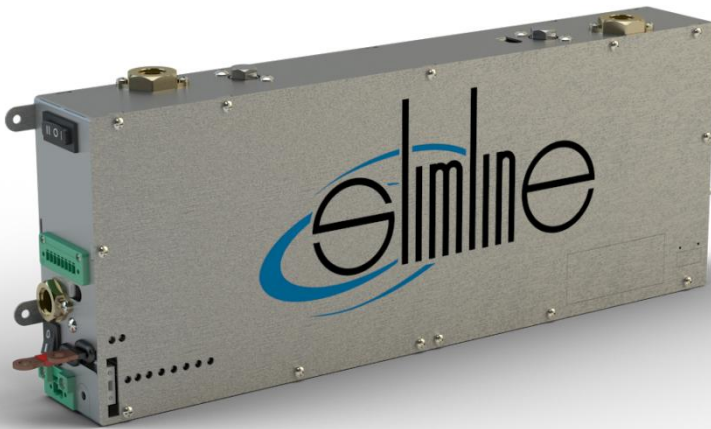

CONTENTS

INTRODUCTION	4
APPLICATIONS	5
EXCHANGE MODULES	6
NAMING OF THE SLIMLINE SYSTEM COMPONENTS	7
SLIMLINE CONFIGURATIONS	8
PRECAUTIONS	12
WARNINGS FOR USE	12
ITEMS PACKED WITH THIS SLIMLINE	13
SLIMLINE COMPONENTS	13
INSTRUCTION STEPS	14
INTERFACE PART NAMES	15
MECHANICAL INSTALLATION INSTRUCTIONS	17
POSITIONING THE SLIMLINE	17
EXTERIOR EXCHANGE MODULE [EEM]	18
INTERIOR EXCHANGE MODULE [IEM]	18
RADIATOR/FAN COMBINATION AS EEM	19
RADIATOR/FAN COMBINATION AS IEM	19
LIQUID-TO-LIQUID HEAT EXCHANGER AS EXCHANGE MODULE	20
PASSIVE RADIATOR AS EXCHANGE MODULE	21
BUFFER RESERVOIR AS EXCHANGE MODULE	21
LIQUID COLD PLATE	22
GROUND SOURCE HEAT PUMP	22
PROCESS WATER	23
COOLING PLATE	23
HEAT STORAGE BUFFER	24
FREE FORM	24
LIQUID CIRCULATION CUSHION	25
COIL	25
VESSEL	26
COMBINATIONS	26
TEMPERATURE CONTROLLER [OPTIONAL]	26
ELECTRICAL INPUT	27
LIQUID CONNECTORS	27
TUBING	28
ELECTRICAL INSTALLATION INSTRUCTIONS	29
MAIN POWER CONNECTION [12-24VDC]	30
MAIN POWER CONNECTION [230VAC]	31
CONTROL BOARD TEMPERATURE [OPTIONAL]	32
ON/OFF SWITCH	37
HEATING/COOLING SWITCH INTERIOR LOOP	37
EXTERIOR FAN CONNECTION [OPTIONAL]	39
INTERIOR FAN CONNECTION [OPTIONAL]	40
SAFETY FUSE	41
CONTROL BOARD CONNECTION	41

TIPS	42
OPERATING INSTRUCTIONS	43
FILLING BASIC	43
FILLING ADVANCED	45
TIPS	46
STARTUP	47
OPERATING TEMPERATURE CONDITIONS	48
OPERATING PRESSURE	48
OPERATING LIQUIDS	48
MAINTENANCE	49
ADDITIONAL INFORMATION	50
TEMPERATURE LIMITER	50
LEVEL SWITCH (BASIC)	50
LEVEL SWITCH (ADVANCED)	51
FLOW SWITCH	51
FILTERS	52
SAFETY FUSE	53
SYSTEM CONTROL LED'S	54
TROUBLESHOOTING	55
SAFETY INSTRUCTIONS	58
TIPS	58
TECHNICAL DATA	59
DIMENSIONS	59
TECHNICAL SPECIFICATIONS	59
MISCELLANEOUS	60
MARKS USED	60
ENVIRONMENTAL	60
CERTIFICATIONS	61
STORAGE AND TRANSPORT	62
DISCLAIMER AND WARRANTY	62
DISCLAIMER	62
WARRANTY	63

Thank you for purchasing module(s) of the Slimline system. Please read this manual carefully before installing and operating the product. Always keep it on hand for quick reference.

INTRODUCTION

The Slimline is a multi applicable thermal system that can be used as a cooling/heating device for many different applications.

Never was integrating cooling/heating features so easy, thanks to the plug-and-play functionality of this new modular low pressure water circulating electric cooling system with integrated liquid pumps, sensors and controllers.

Making use of only environmental friendly materials and using water as main cooling liquid, the Slimline operates as a clever and efficient cooling/heating device and realizes a high efficient heating process by creating a heat pump effect.

The system is the solution for green minded cooling and heating applications.

By directing the cold/heat directly to the desired location with low pressure tubing, the system is setting a new approach for efficient cooling and facilitates all kinds of new smart possibilities.

This advanced cooling and heating system utilizes a patented Peltier technology with the use of standard TCT-units from the renowned and entrusted PowerPack-series.

The module is provided with several components that safely monitor and automatically control the thermal properties of the system. The Slimline is connected to the heat and cold exchange modules.

APPLICATIONS

The Slimline can be used for many different applications. The thermal system is based on the Slimline with two Exchange Modules attached to transfer the heat or cold to the target (Interior) and the ambient (Exterior).

Depending on the desired application the system can be configured by choosing between different Exchange Modules for the Exterior [**EEM**: Exterior Exchange Module] and the Interior [**IEM**: Interior Exchange Module].

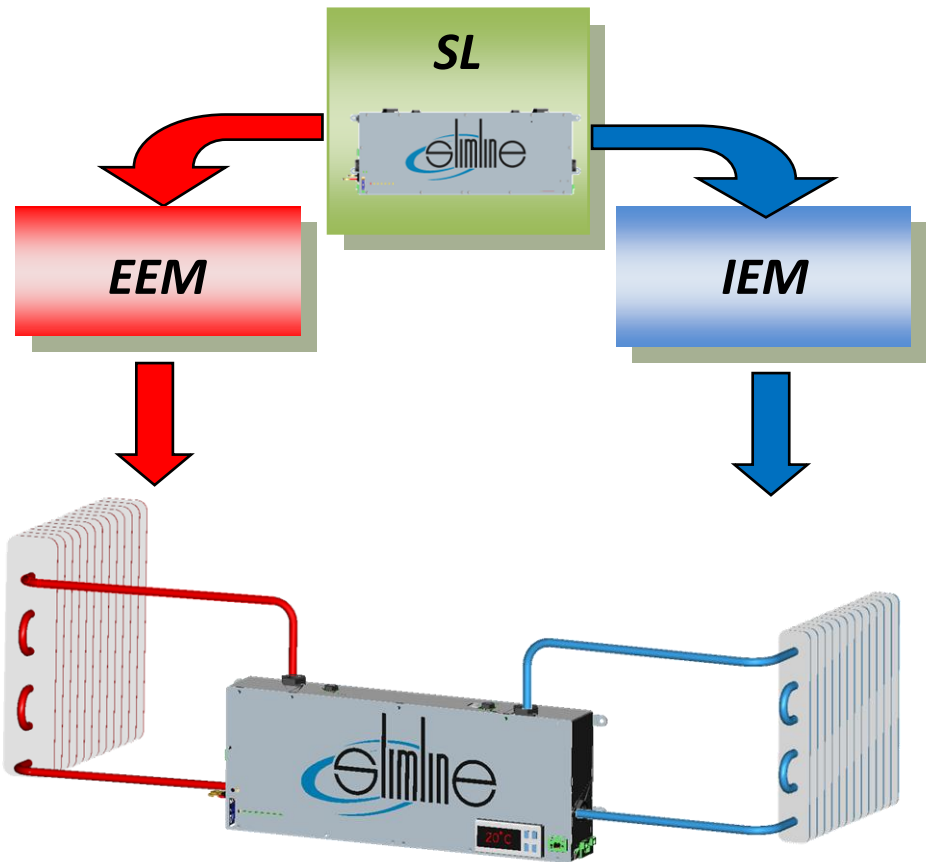

EXCHANGE MODULES

Radiator Fan Combi

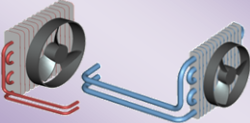

Liquid-to-Liquid Heat Exchanger



Passive Radiator



Buffer Reservoir



Liquid Cold Plate

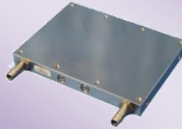

Ground Source Heat Pump

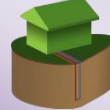

Process Water

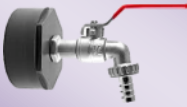

Cooling Plate



Heat Storage Buffer

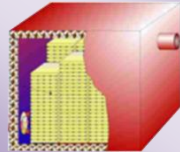

Free Form



Liquid circulation cushion

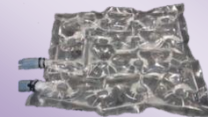

Coil



Vessel



Combinations



Miscellaneous



Examples: Exterior Exchange Modules **EEM** and/or Interior Exchange Modules [**IEM**]

NAMING OF THE SLIMLINE SYSTEM COMPONENTS

To determine what type of system component(s) you have received/ordered, the system was given an article code. The article code is built up as shown in the example below:

For example: SLW-340-19-TCT8-24-C

Module Performance Temperature TEC's Voltage Controller
 ────┬─── - ────┬─── - ────┬─── - ────┬─── - ────┬───
 SLW 340 19 TCT8 24 C

Module	SL	Slimline
	W	Wide
	F	Flat
Performance	340	Cooling power with 100W/°C heat expel at 20°C interior
Temperature	-19	Cools maximum down to this temperature in °C (sub-zero)
TEC's	TCT	Top-Cool Technology
	8	Number of peltier elements (TEC's) in the system
Voltage	24	Voltage on main connection (VDC)
Controller	C	The system contains a temperature controller
Additional separate modules	EEM	Exterior Exchange Module
	IEM	Interior Exchange Module
	KEI	Kit Electrical Installation
	KMI	Kit Mechanical Installation
	KC	Kit Connectors
	CBR	Control Board Remote

SLIMLINE CONFIGURATIONS

The Slimline configurations can be divided in five different types of modules. These modules differ in dimensions and electrical connections.

Slimline	Module	Voltage
	SL	Slimline - 12VDC - 24VDC

The Slimline (SL) is a cooling module with four peltier-elements (TEC's).

See paragraph '**Main power connection [12-24VDC]**' in chapter '**Electrical installation instructions**' for information on how to electrically install a Slimline SL-module.

See the datasheet of your Slimline for more information concerning the needed electrical input and other specifications of your system.

Slimline Wide	Module	Voltage
	SLW	Slimline Wide - 12VDC - 24VDC - 230VAC

The Slimline Wide (SLW) is a cooling module with four or eight peltier-elements (TEC's) depending on the type of SLW. The variant with four TEC's has a built in power supply and can be connected to mains current (230VAC). The variant with eight TEC's has no built in power supply and must be connected to an external 12VDC or 24VDC power supply (depending on Slimline type).

See paragraph '**Main power connection [12-24VDC]**' in chapter '**Electrical installation instructions**' for information on how to connect a Slimline 12VDC, 24VDC SLW-module.

See paragraph '**Main power connection [230VAC]**' in chapter '**Electrical installation instructions**' for information on how to connect a Slimline 230VAC SLW-module.

See the datasheet of your Slimline for more information concerning the needed electrical input and other specifications of your system.

Slimline Wide Exchange	Module	Voltage
	SLWE	Slimline Wide Exchange - 12VDC - 24VDC - 230VAC

The **Slimline Wide Exchange** is a Slimline with a built in power supply and (exterior) exchange module. Therefore only an Interior **Exchange Module (EEM)** must separately be connected to the SLWE.

See paragraph '**Main power connection [12-24VDC]**' in chapter '**Electrical installation instructions**' for information on how to connect a Slimline 12VDC, 24VDC SLW-module.

See paragraph '**Main power connection [230VAC]**' in chapter '**Electrical installation instructions**' for information on how to connect a Slimline 230VAC SLW-module.

See the datasheet of your Slimline for more information concerning the needed electrical input and other specifications of your system.

Slimline Flat	Module	Voltage
	SLF	<p style="text-align: center;">Slimline Flat</p> <ul style="list-style-type: none"> - 230VAC - 12VDC - 24VDC

The Slimline Flat (SLF) is a cooling module with four peltier-elements (TEC's). The SLF has a built in power supply and can be connected to mains current (230VAC).

See paragraph '**Main power connection 230VAC**' in chapter '**Electrical installation instruction**' for more information on how to connect a Slimline SLF-module.

See the datasheet of your Slimline for more information concerning the needed electrical input and other specifications of your system.

Slimline Flat Exchange	Module	Voltage
	SLFE	<p style="text-align: center;">Slimline Flat Exchange</p> <ul style="list-style-type: none"> - 230VAC

The **Slimline Flat Exchange** is a Slimline with a built in power supply and exchange module. Therefore only an **Interior Exchange Module (EEM)** must separately be connected to the SLFE.

See paragraph '**Main power connection 230VAC**' in chapter '**Electrical installation instruction**' for more information on how to connect a Slimline SLF-module.

See the datasheet of your Slimline for more information concerning the needed electrical input and other specifications of your system.

PRECAUTIONS



WARNINGS FOR USE

1. Before installation and operating make sure you have read the user manual.
2. Use the system only with a recommended liquid and without contamination. See chapter OPERATING LIQUIDS for more information.
3. Use the system only within the specified temperature range (because of the limitations of the cooling fluid and TCT-unit). See OPERATING LIQUIDS for more information.
4. Do not use the system on a higher voltage as prescribed.
5. Always secure the main power connection with a safety fuse.

ITEMS PACKED WITH THIS SLIMLINE

- Slimline (**SL, SLW, SLWE, SLF or SLFW**)
- This manual
- **Kit Electrical Installation (KEI)** [optional]
- **Kit Mechanical Installation (KMI)** [optional]
- **Interior Exchange Module (IEM)**, [optional]
- **Exterior Exchange Module (EEM)**, [optional]

SLIMLINE COMPONENTS

A basic Slimline operating system consists of a number of identifiable system components:

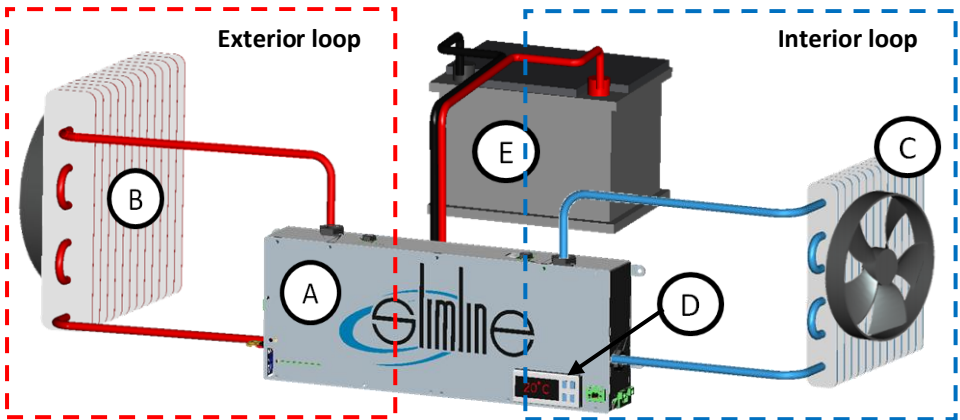



Basic Slimline system in 'interior cooling mode'

- A. Slimline, [**SL (W/F)**]
- B. **Exterior Exchange Module (EEM)**
- C. **Interior Exchange Module (IEM)**
- D. **Control Board Temperature (CBT)**
- E. Power supply

Note: "interior" and "exterior" corresponds to the signals of the system control LED's.

INSTRUCTION STEPS

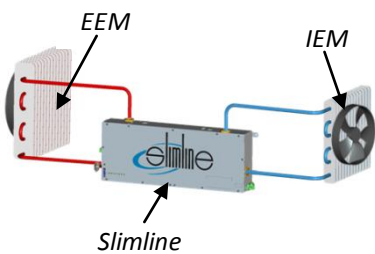
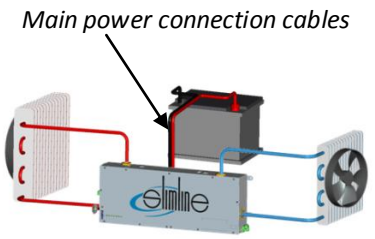
This chapter gives information on how to install a Slimline system. Every set of steps in this chapter is explained more extensive in other chapters in this manual.

See chapter Mechanical Installation Instructions:	
Step 1. Position the Slimline	
Step 2. Place the Exterior Exchange Module [EEM]	
Step 3. Place the Interior Exchange Module [IEM]	
Step 4. Connect the tubing of the IEM and EEM to the Slimline (<i>Kit Mechanical Installation [KMI]</i>) [optional]	
See chapter Electrical Installation Instructions:	
Step 5. Connect the " <i>Kit Electrical Installation (KEI)</i> " [optional]	
Step 6. Connect the main power connection cables/230VAC cable	
See chapter Operating Instructions:	
Step 7. Start the system and fill the interior and exterior loop with cooling liquid	

INTERFACE PART NAMES

1. Filling plug interior
2. Outlet coupling interior
3. System control LED's
4. Inlet coupling interior
5. Interior fan connection

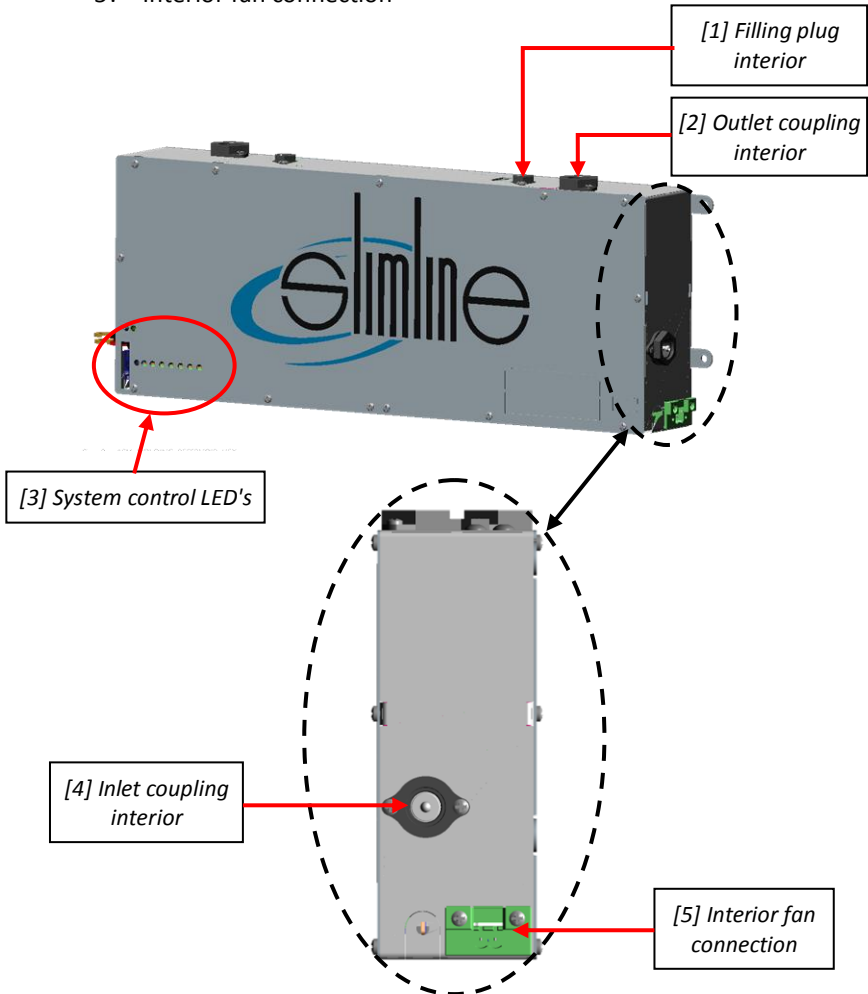

Interface part names interior loop

6. Filling plug exterior
7. Outlet coupling exterior
8. Inlet coupling exterior
9. On/off switch
10. Exterior fan connection
11. Heating/cooling switch
12. Control board connection
13. Main power connections

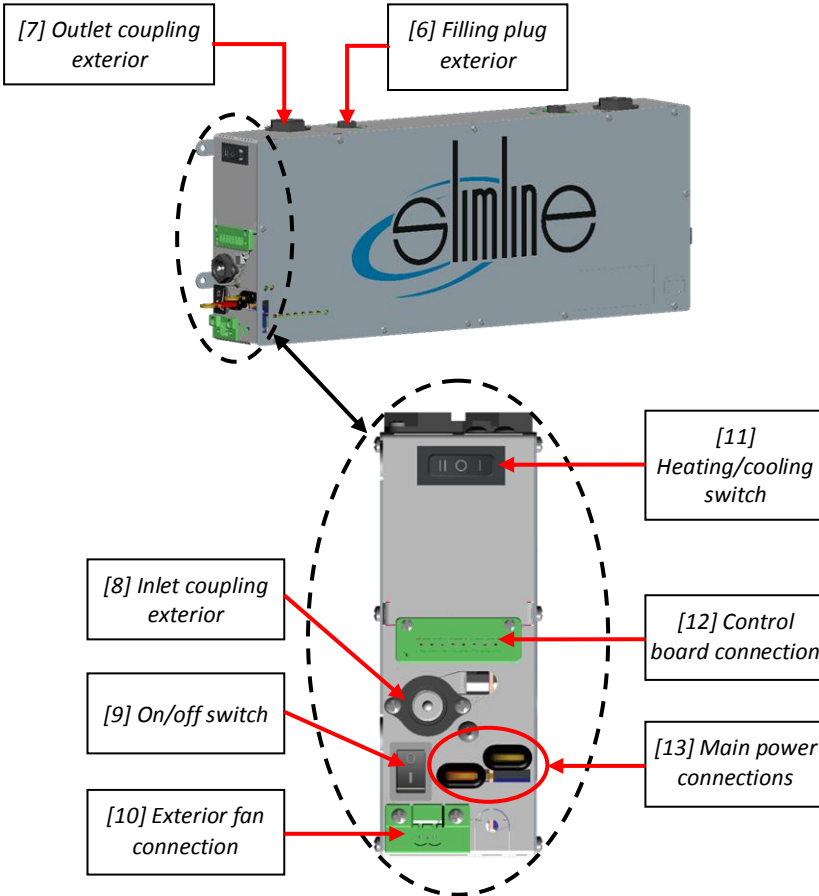

Interface part names exterior loop



MECHANICAL INSTALLATION INSTRUCTIONS

These instructions describe how to install a Slimline system mechanically.



POSITIONING THE SLIMLINE



Step1. Position the Slimline

It's strongly preferred to mount the system horizontally and not at a large angle, otherwise the system will shut down. Ensure to mount the module tightly so it cannot move or shift while operating. We recommend using the mounting lugs (4,5mm) of the Slimline for mounting the system.

Mounting lug (4,5mm)

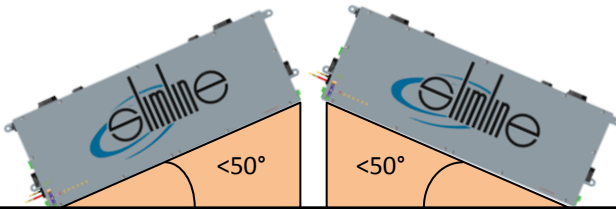
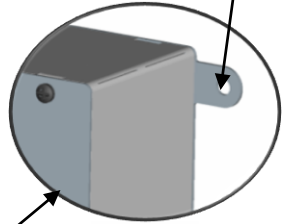

When completely filled, the system will shut down at an angle $>50^\circ$

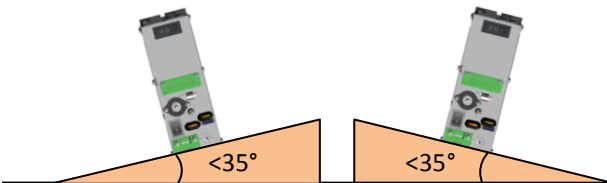

When completely filled, the system will shut down at an angle $>35^\circ$

Positioning of the Slimline



It is important to clear some space around the Slimline for the heat expel of the internal electric components in the device. There is no need for an additional forced air flow as long as sufficient heat expel is maintained for the system/housing.



Not every Slimline does shut down when positioned under an angle. See chapter '*Filling advanced*'. Special types of Slimlines can be positioned under an angle after being filled.

EXTERIOR EXCHANGE MODULE [EEM]



Step 2. Place the Exterior Exchange Module [EEM]

The Exterior Exchange Module (EEM) is most commonly used for the heat exchange to the ambient in cooling mode (see examples on page 6). Therefore the EEM must normally be larger than the IEM. When more heat is expelled with the EEM the cooling performance of the Slimline will raise. The EEM tubing does not need to be insulated.



To create a high performance cooling system it is very important to expel sufficient heat in the Exterior loop. Therefore this loop must be connected to a suitable exchange module.



For a good operating system a common temperature difference between the average liquid (inlet and outlet) temperature and the ambient temperature is **maximum 10°C**.

INTERIOR EXCHANGE MODULE [IEM]



Step 3. Place the Interior Exchange Module [IEM]

The type of IEM (Interior Exchange Module) can be different for every cooling application (see examples on page 6). The IEM is responsible for conditioning for example a volume or liquid (target).



RADIATOR/FAN COMBINATION AS EEM

A radiator/fan combination is the most commonly used EEM for the Slimline. It is important to install a radiator/fan combination as EEM according to the following tips:

1. Use a fan that operates on the same voltage as the main connection of the Slimline (not when using a 230VAC Slimline). Check the datasheet of your Slimline to see which voltage applies to your system.
2. It is recommended to place the radiator on a position where relatively cold air is drawn through the radiator. Avoid pre-heated air entering the radiator.
3. For reaching a better performance it is possible to increase the air flow through the radiator.
4. Ensure that moisture and water on the radiator caused by condensation or dehumidification can be drained when the EEM is used for cooling.
5. When using the IEM for cooling, the liquid tubing of the EEM should not be insulated to reach a better cooling performance.



RADIATOR/FAN COMBINATION AS IEM

A radiator/fan combination is the most commonly used IEM for the Slimline. To create an optimal performing radiator/fan combination it is important to install them according to the following tips:

1. Use a fan that operates on the same voltage as the main connection of the Slimline. Avoid using a high power fan to prevent the created heat by this fan to reduce the cooling power of

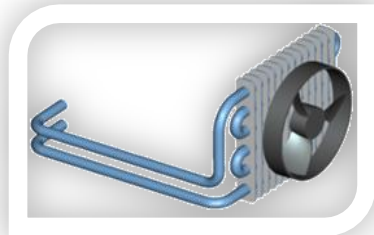

the system. Check the datasheet of your Slimline to see which voltage applies to your system.

2. Try to place the radiator on a position where relatively cold air is drawn through the radiator. Avoid pre-heated air entering the radiator.
3. For reaching lower temperatures of the out coming airflow it is possible to; reduce the airflow (speed), use a smaller radiator or using recirculation.
4. Ensure that moisture and water on the radiator caused by condensation or dehumidification can be drained when the radiator is colder than the ambient temperature.
5. Cover the liquid tubes/couplings that connect the radiator to the Slimline with insulation foam or reduce the length of the tubing, to prevent unnecessary loss of cooling/heating power.



LIQUID-TO-LIQUID HEAT EXCHANGER AS EXCHANGE MODULE

A liquid-to-liquid heat exchanger can be used for heat expel or cooling different liquids within one system. It can also be used for the indirect cooling of high pressure liquid loops.



When using a heat exchanger it is important to use the following tips:

1. Take in account that not every liquid has the same heat capacity. Therefore it can take longer for one of the liquids in the exchanger to cool down/ heat up than for the other.
2. Use a heat exchanger that is made of good conducting materials that fits the cooling capacity.
3. Insulate the heat exchanger to improve the performance of the heat exchanger (only helpful when heating or cooling to a temperature below ambient).



PASSIVE RADIATOR AS EXCHANGE MODULE

A passive radiator can be used as a soundless cooling/heating module but will not be as efficient as an active module. Use the following tips to optimize the performance of a passive radiator.



1. Use a radiator that can exchange sufficient heat to create good performance. See the datasheet of your Slimline for more information on the needed heat exchange for your system.
2. The pressure drop in the Slimline caused by the radiator must be within the specifications of the Slimline. See the datasheet for more information.



BUFFER RESERVOIR AS EXCHANGE MODULE

To cool/heat (peak cooling) larger volumes of liquid a buffer reservoir can be used. When using a buffer reservoir:



1. The cooling/heating time of the cooling liquid is depending on the heat capacity of the used cooling liquid.
2. The heat loss (in Watt) of the reservoir may not be bigger than the cooling power of the Slimline. Therefore the reservoir must be insulated properly (only helpful when heating or cooling to a temperature below ambient).
3. Try to position the buffer reservoirs on the same level as the Slimline to prevent the Slimline from overflowing because of the liquid pressure in the buffer reservoir. When choosing to position the Slimline on a higher level, keep in mind not to exceed the maximal pressure in the system. Also be aware of the maximal water head of the used pumps.



LIQUID COLD PLATE

A liquid cold plate can be used as a soundless cooling/heating module but will not be as efficient as an active module. Use the following tips to optimize the performance of a liquid cold plate.

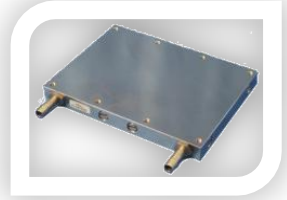

1. Use a liquid cold plate that can exchange sufficient heat to create good performance. See the datasheet of your Slimline for more information on the needed heat exchange for your system.
2. The pressure drop in the Slimline caused by the liquid cold plate must be within the specifications of the Slimline. See the datasheet for more information.
3. Use a high conductive material for the liquid cold plate to create sufficient heat/cold expel.



GROUND SOURCE HEAT PUMP

1. Use pipe/tubing that can exchange sufficient heat/cold to create good performance. See the datasheet of your Slimline for more information on the needed heat exchange for your system.
2. Take in account that the used pipe/tubing creates a flow resistance. Make sure that the water flow in the ground source heat pump despite the flow resistance is still more than 1,2L/min.





PROCESS WATER

1. The liquid flow of the process water must be more than 1,2L/min.
2. Using process water as EEM that is colder than the ambient temperature of the Slimline improves the performance of the Slimline.
3. Use clean process water (no contamination).
4. Do not exceed the maximum internal pressure of the Slimline (max. 1,0bar).

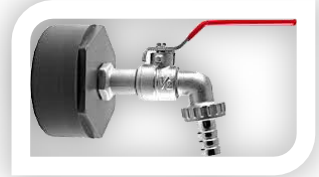

COOLING PLATE

A liquid cooling plate can be used as a soundless cooling/heating module but will not be as efficient as an active module. Use the following tips to optimize the performance of a liquid cold plate.

1. Use a cooling plate that can exchange sufficient heat to create good performance. See the datasheet of your Slimline for more information on the needed heat exchange for your system.
2. The pressure drop in the Slimline caused by the cooling plate must be within the specifications of the Slimline. See the datasheet for more information.
3. Use a high conductive material for the cooling plate to create sufficient heat/cold expel.





HEAT STORAGE BUFFER

A heat storage buffer can be used for temporary storing energy that can be used for improving cooling performances.

1. Do insulate the heat storage buffer.
2. Make sure the liquid in the buffer is circulating to create an equal liquid temperature in the reservoir.

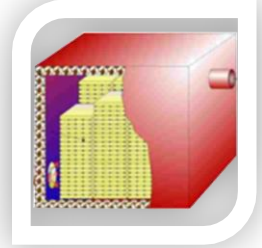

FREE FORM

Besides the commonly used modules for heat/cold exel there can also be used '*free form*' exchange modules. These modules can be shaped in every possible way. Use the following tips when using a free form as exchange module:

1. Use a design/shape that can exchange sufficient heat/cold to create good performance. See the datasheet of your Slimline for more information on the needed heat exchange for your system.
2. The pressure drop in the Slimline caused by the exchange module must be within the specifications of the Slimline. See the datasheet for more information.





LIQUID CIRCULATION CUSHION

A liquid circulation cushion can be used for cooling/heating a chair or pillow. Use the following tips when designing a liquid circulation cushion.

1. Use a cushion that can exchange sufficient heat to create good performance. See the datasheet of your Slimline for more information on the needed heat exchange for your system.
2. Use a cushion that can handle the liquid pressure of your Slimline.



COIL

A coil can be used in situations where volumes have to be conditioned uniform without using an active airflow. It can also serve as a heat exchanger. Tips for using a coil as exchange module are:

1. Use a coil that can exchange sufficient heat/cold to create good performance. See the datasheet of your Slimline for more information on the needed heat exchange for your system.
2. Use a high conductive material for the liquid cold plate to create sufficient heat/cold expel.

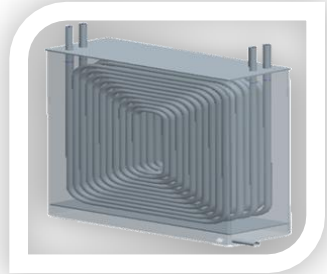



VESSEL

A vessel can be used for heating/cooling larger volumes of liquid. Use the following tips to make your vessel as efficient as possible.

1. The heat loss (in Watt) of the reservoir may not be bigger than the cooling power of the Slimline. Therefore the reservoir must be insulated properly.
2. Try to position the buffer reservoirs on the same level as the Slimline to prevent the Slimline from overflowing because of the liquid pressure in the buffer reservoir.



COMBINATIONS

It is possible to combine the described exchange modules. It is recommended to use the tips mentioned in this manual for every single module you are using and integrate them into your combined exchange module.



TEMPERATURE CONTROLLER [OPTIONAL]

The purpose of the temperature controller is to control and monitor the system while operating. The temperature controller regulates the temperature of the volume you want to heat/cool. The sensor is connected to the interior loop of the Slimline.

The Slimline has a connector that is meant for connecting a temperature sensor to the temperature controller that gives the possibility to adjust the temperature controller from a distance.

There are also types of Slimlines with a built in temperature controller.

ELECTRICAL INPUT

Some variants of the Slimline must be connected to a direct current power supply (VDC) these power supplies must have an outgoing voltage equal to the main voltage of the Slimline. Use a power supply, battery, generator, etc. with sufficient power and adequate connections. For more information on how to connect the power supply and what power supply to use see chapter: **Electrical Installation Instructions** and the datasheet of your Slimline.

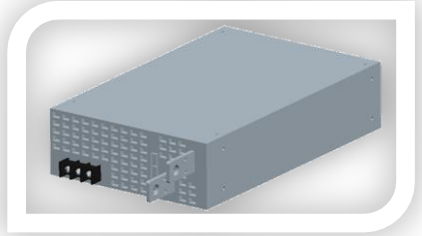

Power supply

LIQUID CONNECTORS

Step 4. Connect the tubing of the IEM and EEM to the Slimline (**Kit Mechanical Installation [KMI]**) [optional]

The Slimline has two separate liquid loops. These loops are called the interior and exterior loop. The interior loop is responsible for the conditioning of the interior ambient (target). These loops have a liquid flow generated by integrated pumps. The exterior loop takes care of expel of heat/cold into the exterior ambient. The Slimline has four liquid couplings (two interior and two exterior) that can be connected to the IEM and the EEM. When using an SLFE-module, the exterior liquid couplings are already connected.

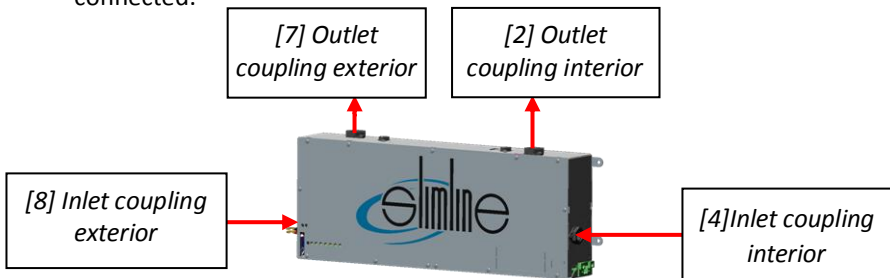

Liquid couplings for connecting the interior and exterior loop to the Slimline (See "Interface part names" for corresponding numbers)

Another coupling must manually be mounted onto these liquid couplings. These couplings did not come with the Slimline



For male BSP couplings it's strongly advised to use a sealing cord and place it inside the thread. We recommend using Loctite 55, make at least 3-4 full crosswise loops and mount the couplings into the liquid connectors.

Example of a properly used sealing cord:

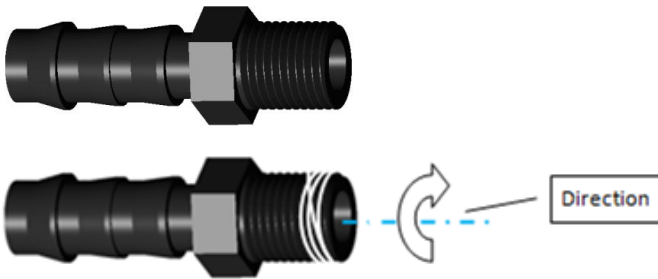

TUBING

The Slimline can be connected to an EEM & IEM with flexible tubing and runs on a low pressure liquid flow (ca. 1 bar, 14.5 PSI). Use appropriate tubing with an inner diameter of at least 10mm to maintain sufficient flow. Always keep the length of the tubing to a minimum. Use couplings or anti-kink features to ensure that the tubing will not kink. Be aware that kink can occur more easily at higher temperatures because most tubing gets more flexible at high temperatures.



ELECTRICAL INSTALLATION INSTRUCTIONS

The following information is very important for a good and safe working system. Electrical work should be performed by a qualified operator, always observe local applicable codes or regulations.

These instructions describe how to electrically install a Slimline system.

Step 5. Connect the "Kit Electrical Installation (KEI)" [optional]

The most important electric connections of the Slimline are the main power connections [13]:

- Main power connection (+)
- Main power connection (-)



[13a] Main power connection (+)

[13b] Main power connection (-)

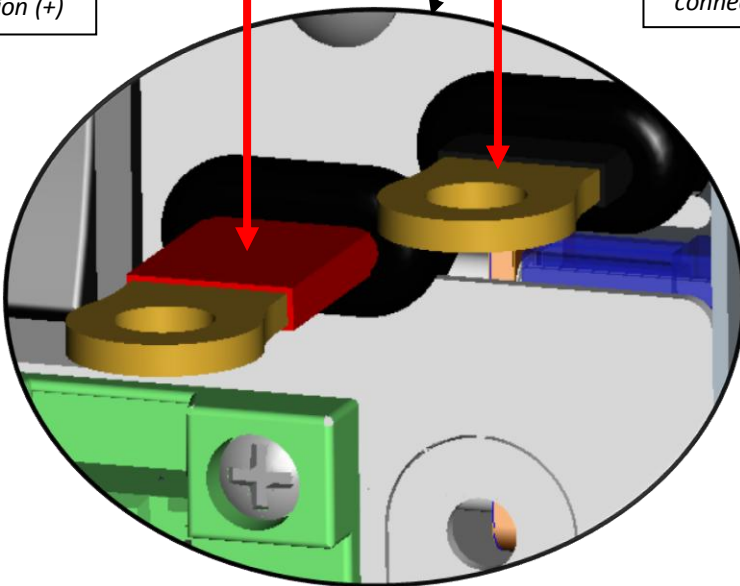

Main power connections



MAIN POWER CONNECTION [12-24VDC]

Step 6. Connect the main power connection cables/230VAC cable

The main power connections provide the power supply for the whole system. It gives electric power to all components in the Slimline. The power should be connected by using an eyelet mounted with an M6 screw, nut and lock washer onto the main connections (**see picture: Connecting the main power connections**). These connections must be mounted tight to prevent the connections from heating up and causing hazardous situations due to insufficient electrical contact between the components.



It is obliged to also clamp/support the electric wires of the main connection onto another solid component near the main connection, to prevent the wires from moving or vibrating and applying forces onto the connections that can possibly damage them or have safety effects.

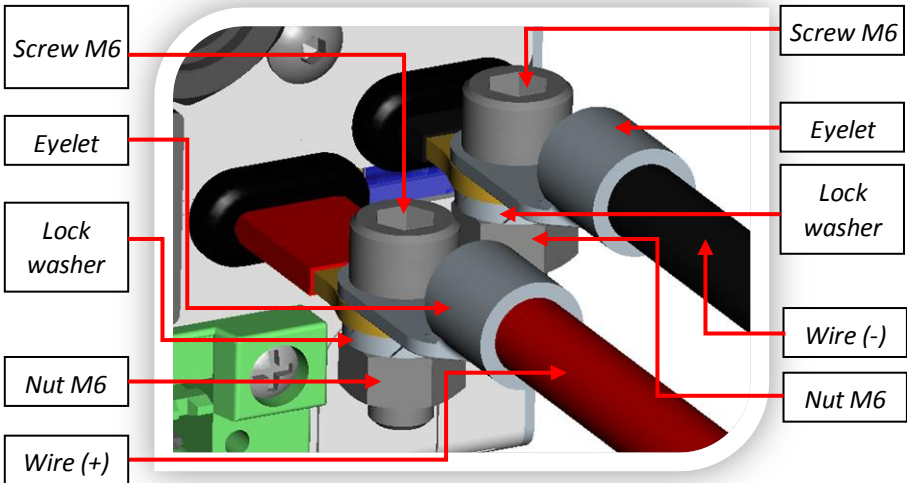

Connecting the main power connections



Make sure that the electric connections do not touch each other while operating. It is recommended to use eyelet covers to cover the connections. Whether to use a 12VDC or 24VDC power supply depends on the type of Slimline.



Eyelet covers [13a]



[13b]

The Slimline works with relatively high currents while operating, due to the high power on low voltage. To make sure the system will operate efficient and non hazardous it is important to choose the correct wire thickness for the main connections. Always fuse the main connections!



MAIN POWER CONNECTION [230VAC]

Some Slimline variants have a built in power supply. These types of Slimlines can be connected to mains current (230VAC) and consist of a 230VAC cable connection.



230 VAC cable



230 VAC cable connection



CONTROL BOARD TEMPERATURE [OPTIONAL]

Programming the temperature controller (Basic version)

The temperature controller can be used for heating and cooling and can manually be set to a temperature. Before the controller starts to regulate the temperature, you must set it for cooling or heating (depending on your application).

Press **'set'** until **HC** appears on the display. Press **'set'** again and use the arrows to select the **H (Heating)** or the **C (Cooling)** and wait five seconds. When the controller is set to cool, the interior loop is cooled down until the set temperature is reached. The Slimline then stops cooling. When the controller is set to heat, the interior loop is heated up to the set temperature.

Wait until the display returns to the temperature display again. Press **'set'** again and use the arrows to select the temperature you want the interior loop of the Slimline to reach. Finally you have to press **'set'** again or wait to complete the programming. The controller will now start to control the temperature.

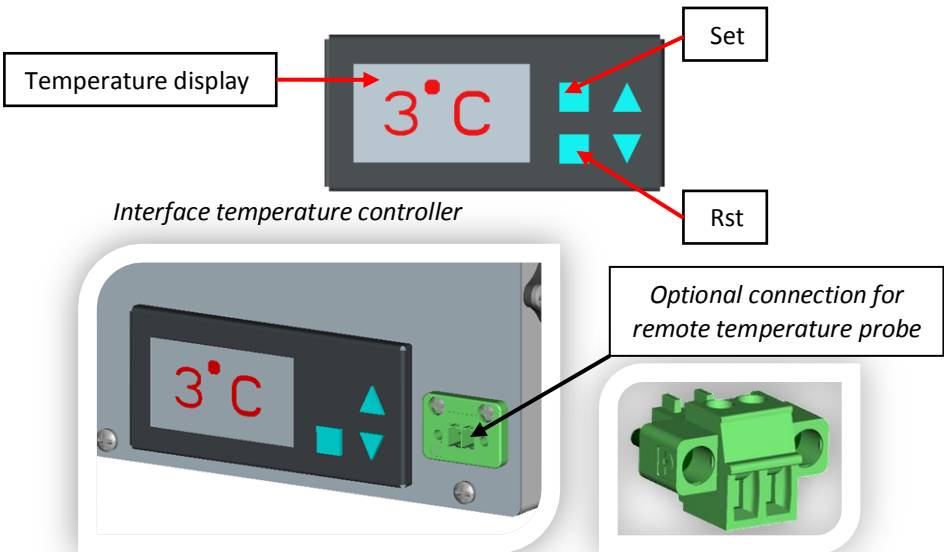

Power connector female (MC1.5/2-STF-3.81 [PN 1827703])

This Controller does only regulate the temperature. It does not reverse the Slimline. Therefore the Slimline must manually be set to heating/cooling by using the 'Heating/Cooling switch'.



Heating/Cooling switch



The standard setting of the temperature controller as you received it is as follows:

parameters	value	description
HC	H or C	H for Heating and C for Cooling
D	01	Hysteresis
LS	-20	Min. temperature setpoint
HS	50	Max. temperature setpoint
CA	00	Calibration (temperature correction)
P7	00	Delay protection function

If you want to adjust these parameters, you have to press the '**set**' key and hold it for three seconds. Now you will enter the menu display, the display will now show '**HC**'. Use the arrows **▲▼** to select the parameter you want to adjust. Press '**set**' to unlock the parameter and use the arrows to adjust the parameters and wait three seconds to confirm them.

Electric wiring

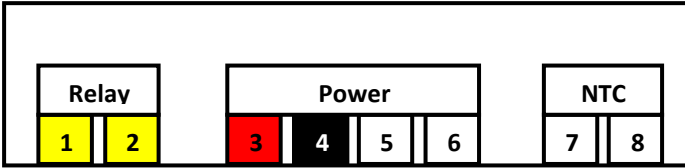

1. Relay (yellow)
2. Relay (yellow)
3. + 12V (red)
4. - 12V (black)
5. not connected
6. not connected
7. NTC (temperature sensor)
8. NTC (temperature sensor)

Function description

- temperature measurement and control -25°C until 150°C
- temperature tolerance $\pm 0,5^{\circ}\text{C}$
- sensor model NTC (100K)
- control precision 0,1°C
- voltage = 12VDC ; current = max. 50mA
- relay max. 5A/230V
- working environment 0°C - 50°C

Programming the temperature controller (Advanced version)

parameters	value	description
passcode	77	passcode
C0	4	Operation mode (4 = PWM)
P1	1,0	Set point 1 differential in °C
P2	1,0	Set point 2 differential in °C
P3	0,5	Dead zone differential in °C (hysteresis zone)
C5	0	Type of control (P-control = 0 en PI-control = 1)
C12	0,2	Pulse Width Modulation in seconds (high frequency)
ST1	°C	Setpoint = regeltemperatuur in graden Celsius

1. Before the controller can be connected it must be set to the correct program by selecting the passcode. This passcode can be entered when holding the **prg** and **set** button together for 5 seconds during the start-up of the controller. The next step is to select the passcode. For this controller the passcode is **77**, select the code by using the arrows and press set when you have selected the passcode.
2. After selecting the passcode, the controller can be programmed. The first parameter that must be set is the c0. Press set to select this parameter and use the arrows to adjust this parameter to a value of **4**. Press **set** to confirm.
3. Press ▲ to continue to parameter p1. Press set to select this parameter and adjust its value to **1.0**. Press **set** again to confirm.
4. Press ▲ and select parameter p2. Adjust its value to **1.0** and press set to confirm.
5. Press ▲ and select parameter p3. Adjust its value to **0.5** and press set to confirm.
6. Press ▲ and select parameter c5 and c12 and adjust them respectively to **0** and **4**.
7. Press the **prg** button during 5 seconds to save all settings.
8. The last step is to set the temperature of the controller. Push the **set** button for five seconds. The display will start to blink and show a number. This number is the set temperature. This temperature can be adjusted by using ▲ and ▼. Press set to confirm the selected temperature.



Temperature controller IR33W7LR20 (advanced version)

Electric wiring

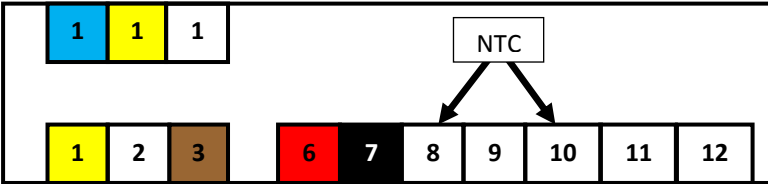

- 1. Relay (yellow)
- 3. Heating (brown)
- 6. + 12V (red)
- 7. - 12V (black)
- 8. NTC (temperature sensor)
- 10. NTC (temperature sensor)
- 13. Cooling (blue)
- 14. Relay (yellow)



Connecting the IR33W7LR20 (advanced version)

Function description

- temperature tolerance $\pm 0,5\%$
- sensor model NTC (10K)
- control precision $0,1^{\circ}\text{C}$
- voltage = 12 to 24VAC ($\pm 10\%$), 12 to 30VDC
- working environment $-10^{\circ}\text{C}/50^{\circ}\text{C}$
- operating humidity $< 90\%$ rH
-



ON/OFF SWITCH

The Slimline can be switched on and off by the On/off switch. When this system is in the off position it is not possible to start cooling or heating. To start the system you must first connect the main power connections [13] to a power supply and switch the on/off switch to its 'on' position. When the system is on it will start heating or cooling depending on the setting of the heating/cooling switch.

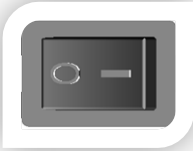

On/off switch (I: on, 0: off)



HEATING/COOLING SWITCH INTERIOR LOOP

The cooling engine (TCT-units) can then be controlled in three different ways:



Heating/Cooling switch (II: interior warm, 0: off/passive and I: interior cold)

II: interior warm

In this mode the system will warm the interior loop up and cool the exterior loop down. The red LED on the Slimline interface will light up.

0: off/passive

When the switch is in the off position the TCT-unit(s) in the Slimline are shut down. The Slimline can also cool passive when the on/off switch is on.



I: interior cold

In this mode the system will cool the interior loop down and heat the exterior loop up. The blue LED on the Slimline interface will light up.



EXTERIOR FAN CONNECTION [OPTIONAL]

Connect the exterior fan (EEM) [9] electrically.

- (+) Connection for exterior fan
 - (-) Connection for exterior fan
- (See the datasheet for reference on which voltage is applied on the fan connection)*

If a radiator/fan combination is used for the exterior loop it can be connected to the exterior fan connection, the exterior radiator/fan combination will blow the conditioned air into the target environment. The radiator/fan combinations are not standard components of the Slimline (depending on the system configuration) and can therefore separately be connected to the Slimline. Keep in mind that this connection works on the same voltage as the main connection of the Slimline. This connection can also be used for other purposes. The connection is fused by an internal blade fuse.

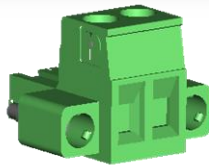
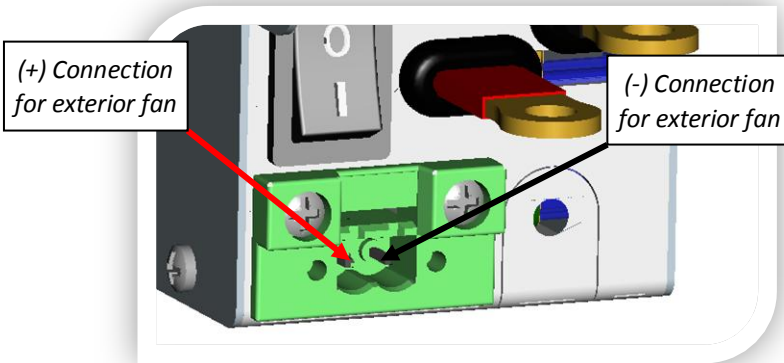

Power connector female (MSTB2.5/2-STF-5.08 [PN 1777989])



INTERIOR FAN CONNECTION [OPTIONAL]

Connect the interior fan (IEM) [5] electrically.

- (+) Connection for interior fan
 - (-) Connection for interior fan
- (See the datasheet for reference on which voltage is applied on the fan connection)*

The interior fan connector enables the radiator to expel its heat/cold to the ambient air by using a fan. This connection can also be used for other purposes. This connection is fused by an internal blade fuse.

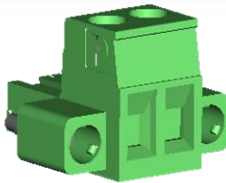
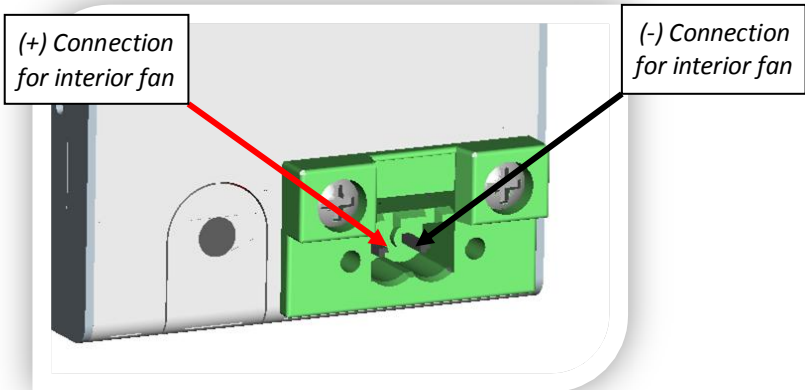

Power connector female (MSTB2.5/2-STF-5.08 [PN 1777989])



SAFETY FUSE

To prevent the components of the Slimline from errors, the PCB of the Slimline is provided with a 15A blade fuse.

Safety fuse

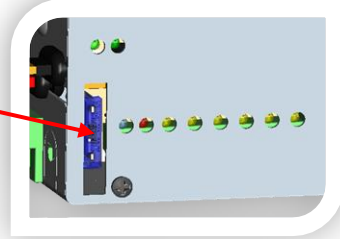

System control LED's [3]



CONTROL BOARD CONNECTION

The control board [12] gives the opportunity to connect an external temperature controller, on/off and cooling/heating switch to the Slimline. To control the Slimline system the following wires must be connected:

1. [white] Power (-) } connect 1. to 2. to start the system
2. [green] On-off (-)
3. [yellow] Switch (-) } connect 3. to 4. to start cooling
4. [blue] Cooling (-) } connect 3. to 5. to start heating
5. [brown] Heating (-)
6. [red] Controller + (12VDC)
7. [black] Controller - (12VDC)
8. Optional connection

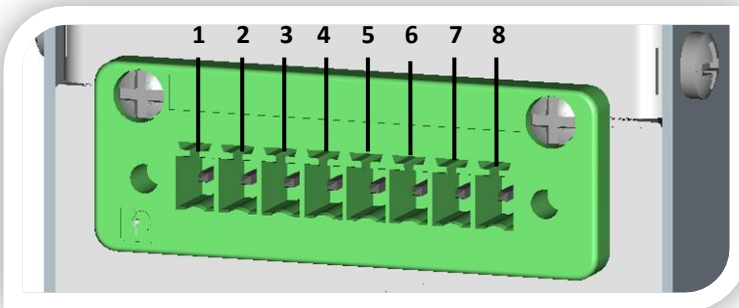

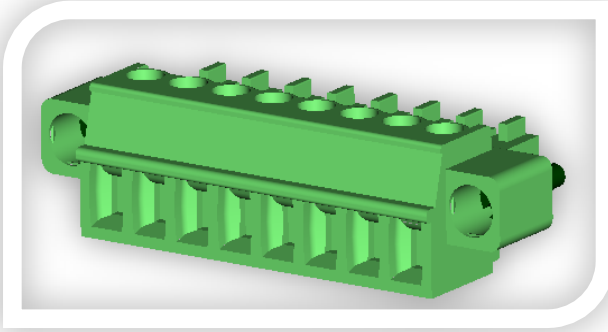

Connector female (MC1.5/8-STF-3.81 [PN 1827761])



Note: When using the control board all switches on the Slimline must be in their off position.



TIPS

1. Electrical work should be performed by a qualified operator, always observe applicable codes or regulations.
2. Before making any modification in your system, turn off the electric power and disconnect the main connections of the system.
Use cable end sleeves for a proper connection of the wires into the connectors.
3. Choose a wire thickness that is suitable for the current that it is used for

OPERATING INSTRUCTIONS

This chapter will give instructions on how to startup the system after mechanical and electrical installation.



FILLING BASIC

Step 7. Start the system and fill the interior and exterior loop with cooling liquid

Before the system is operational, the system has to be filled with a cooling liquid. This can be done by filling the reservoirs in the Slimline. Therefore the filling plugs [1] & [6] must be taken out of the reservoirs. See chapter "OPERATING LIQUIDS" to see what liquid to use. Before the system can be filled it has to be started.

There are two filling plugs [1] & [6] mounted on top of the Slimline which can be removed for filling the internal reservoirs and liquid loops of the Slimline (**see picture:** Filling the Slimline). While filling it is recommended to activate the Slimline for a gradually filling of the reservoir/system. Therefore the filling can best be done after all mechanical and electric components are already installed.



The liquid level in the reservoirs should approximately reach up to 5mm below the top of the screw thread of the filling plugs while the pumps are running at room temperature. When both loops are filled with cooling liquid the whole system is ready to use.



The plugs must be mounted back onto the Slimline with a torque of 0, 5Nm to ensure proper sealing. Do this while the pumps are still running to prevent the reservoir from overflowing, especially when parts of the liquid loops are on a higher level than the filling plugs of the Slimline. The reservoirs must contain approximately 80ml of cooling liquid. Do not forget that the whole interior and exterior loop must also be filled. The amount of liquid that is needed for filling the exchange modules and tubes depends on the chosen IEM/EEM and tube lengths.



Make sure that the amount of liquid in the different loops (interior and exterior) is maximal 2 liters each. This includes the reservoir, tubes and exchange modules. This prevents exceeding the maximal acceptable internal pressure of the reservoir due to liquid expansion during heating. Otherwise an overpressure valve or another expansion option is mandatory.

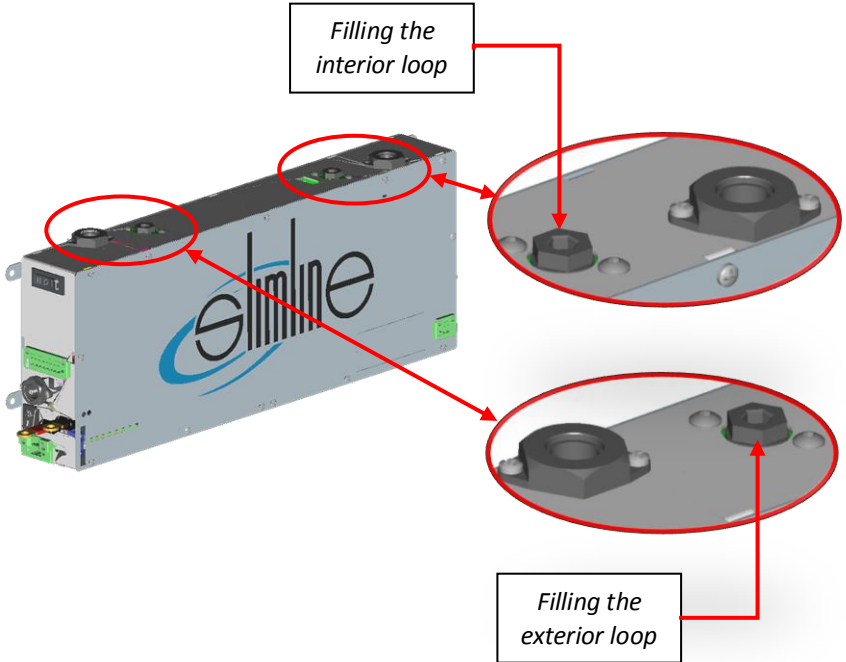

Filling the Slimline



For easy filling, it is recommended to fill the reservoir with a funnel or a wash bottle.



Funnel (left) and wash bottle (right)



The system is designed for easy filling by a non technical/or certified operator. When filling, the pumps will turn on and off until the reservoirs are filled up to a sufficient level. When this level is reached, the pumps will continuously be running.



FILLING ADVANCED

The '*Slimline advanced*' is a shockproof variant of the Slimline series that can be positioned under any angle. This is not possible when using the '*Slimline basic*'.

Normal filling of the Slimline is not possible in these situations since the filling plugs of the Slimline are positioned on top of the system. Therefore the exterior and interior loop of your system needs to consist of a buffer reservoir that can be used for filling. This should be an open buffer for de-aeration reasons. The buffer also needs to be on the highest point of the separate loops.

When the buffer reservoirs are filled you can push the filling button to fill the rest of the loop (both loops have their own filling button). Do only push these buttons when there is sufficient liquid left in the buffer reservoir, to prevent the pumps from running dry.

Every Slimline consists of a couple of safety components that prevent the Slimline from hazardous situations.

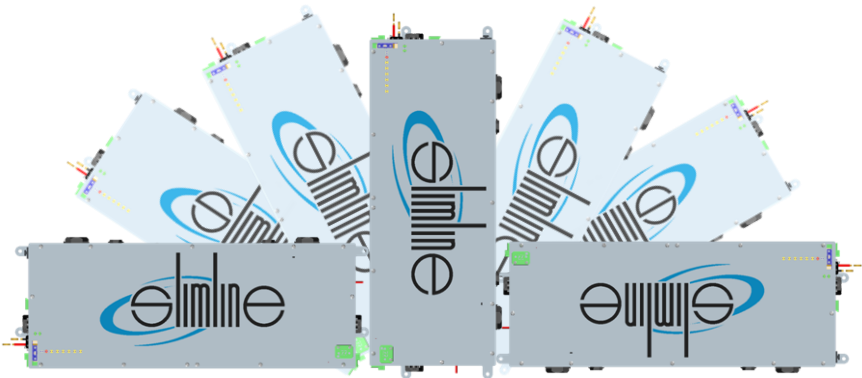

The Slimline advanced can be positioned under any angle

TIPS

1. If the IEM/EEM is mounted on a higher position than the reservoirs of the Slimline, the reservoirs will overflow by the fluid pressure in the IEM/EEM when the filling plug is demounted. To prevent the reservoir from overflowing it is recommended to (re)fill the reservoirs while the pumps of the Slimline are already running. This can only be done after the module is electrically connected.
2. Note: There is always trapped- and dissolved-air in the liquid that arises after a certain time and will collect in the reservoir, therefore if necessary after one hour give the reservoir a refill.
3. It is recommended to refill to the maximal level (up to 5mm of the screw thread edge of the filling plug). See picture.
4. An additional reservoir can be used and is available for buffering some extra liquid in each loop of the Slimline.

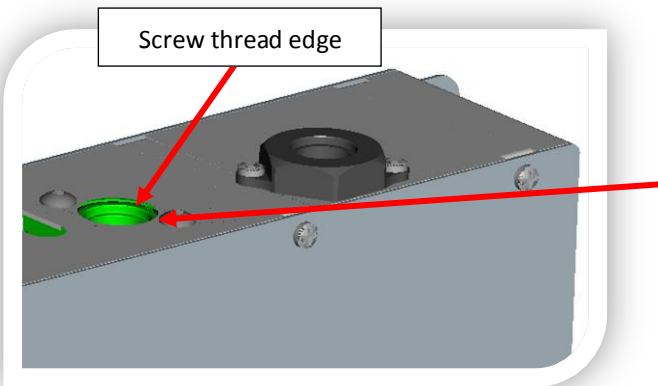

Filling the Slimline



Buffer reservoir

STARTUP

When all installation requirements are met, the Slimline is ready for use. Be sure to check if there is no leakage at the liquid couplings of the entire system. Do also check if all actions and requirements of this manual are met.

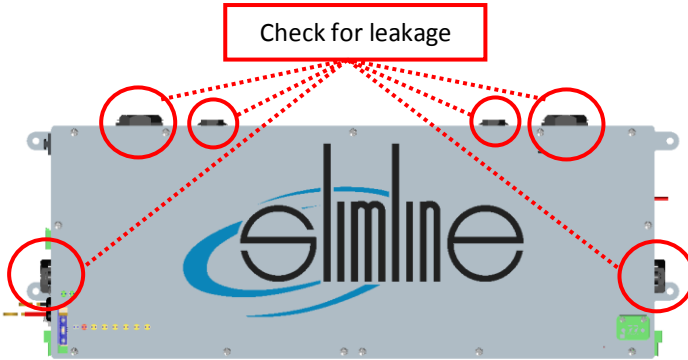

Check for leakage

Let the system run for one hour, after this hour check the following:

1. Check the liquid level in the reservoirs (do not turn the system off while checking).
2. Check again if there is no leakage at the couplings of your installation.



OPERATING TEMPERATURE CONDITIONS

Operating temperature range of a system filled with:

	Water	MEG -10	MPG -10
Hot side out max. (°C)	50	50	50
Cold side out min. (°C)	5	-5	-5
Ambient Slimline max. (°C)	40	40	40
Ambient Slimline min. (°C)	5	-5	-5



Be aware of the reduction of the efficiency of the Slimline when using MEG (Mono Ethylene Glycol) or MPG (Mono Propylene Glycol) because of its worse thermal properties.

OPERATING PRESSURE

The liquid pressure inside the system during operating may maximal be 1,0 bar (14.5 PSI). Always configure the system to not exceed the interior maximum pressure. The flow of the fluid is ca. 2,5 L/min at the outlet coupling but is strongly depending on the flow resistance created by the interior and exterior loop and the used components like the tubing, couplings and the IEM/EEM.

OPERATING LIQUIDS

Only use the following liquids. Top-Cool doesn't support or give warranty if any other liquid is used as stated below.

- Clean water / demineralised water (demineralised water is preferred because it is cleaner)
- Mono Ethylene Glycol (MEG) diluted with water
- Mono Propylene Glycol (MPG) diluted with water

The cold-side of the cooling system can freeze if the liquid used is operating near its freezing temperature. The fluid will always freeze inside the TCT-units first which is not notable.



It is not allowed to regulate the system in a mode that is operating within 5°C of the freezing/boiling point of the used liquid. There will be given no support, and warranty will void when the Slimline is used near these temperature limits.



Observe if the flow is clear of air. Air bubbles in the flow can influence the performance of the Slimline.

The MEG coolant is mixed with water. The mixing ratio determines the freezing temperature of the liquid. This mixing ratio can change due to, for example, evaporation of the water (especially when an open loop is used). Therefore it is recommended to check the mixing ratio of the liquid regularly with a refractometer and to maintain the desired freezing point by adding additional coolant.

MAINTENANCE

The Slimline does not require any maintenance at short terms.



Basic maintenance on system components on long terms:

1. Make sure the liquid level in the reservoir is correct (see chapter '*filling*' for more information).
2. Make sure there is no contamination in the liquid.
If there is contamination clean and refill the reservoir and the related loop.
3. Observe if the liquid flow is clear of air bubbles.
4. Before refilling the reservoirs, make sure the filter is clear of contamination, to prevent the Slimline from running on contaminated cooling fluid. Replace or clean the filter if it is not clean (see chapter "Filters").
5. The exchange module(s) (IEM and EEM) must be cleaned when polluted. Do always secure that sufficient thermal energy can be expelled.
6. When air filters are used, these must be cleaned or exchanged when they are polluted.
7. Regularly control the electric connections and tighten them if they are loose.
8. Regularly check the condition of the liquid tubes and couplings. If they are internally contaminated they can hold back the performance of the Slimline. Replace or clean them if necessary.
9. When the Slimline is polluted, clean the outer surface with a water soaked cloth.

ADDITIONAL INFORMATION

This chapter contains additional information about components that are not visible on the outside of the Slimline but are responsible for preventing the Slimline from malfunctions. This chapter gives you some inside information for reference.

TEMPERATURE LIMITER

The temperature limiters are mounted on top of the TCT-unit(s). These limiters will shut the system down when the outer surface of the TCT-unit has reached a temperature of ca. 45°C. This temperature is reached when the liquid flow inside the TCT-unit has a temperature of ca. 60°C. The limiter protects the internal components of the Slimline. The system will restart automatically when the outer surface of the TCT-unit has cooled down to a temperature of approximately 35°C. At room temperature this takes about 20 min.

LEVEL SWITCH (BASIC)

The level switches check the liquid level inside the reservoirs. If the level of the liquid gets below a certain point, the level switch will shut down the pumps. This problem can be solved by refilling the reservoirs. The refilling must be done by removing the plugs on top of the Slimline. After removing the plugs, the cooling fluid can be poured into the reservoir until the level of the fluid is on an equal height as the starting plane of the screw thread of the filling plug.

It is recommended to remove the filling plug and to fill the reservoirs while the system is still switched on to prevent the system from overflowing. After refilling, the plugs should be mounted back on their positions before the system is shut down again.

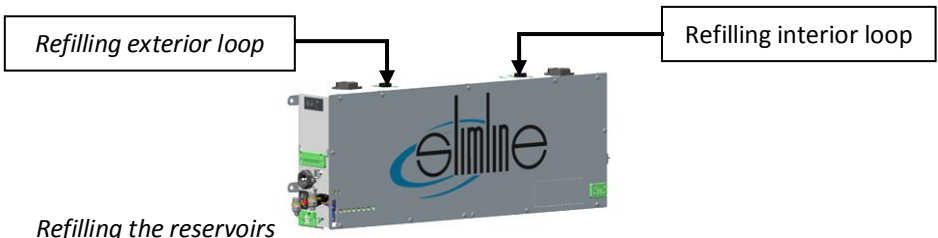

LEVEL SWITCH (ADVANCED)

Not every Slimline is equally controlled. Some Slimlines ('*Slimline advanced*') consist of a specially controlled level switch. In this configuration the level switch does control the filling process of the Slimline but will be overruled when there is sufficient flow in the system. These types of slimlines can resist shocks better and will not shut down when the system is operating under any angle or for example upside down.

FLOW SWITCH

The flow switches monitor if there is a proper liquid flow in both loops of the system. When there is not sufficient liquid flow present (less than ca. 0,8L/min.) as a result of a malfunction (for example when the liquid is frozen or if there is trapped air in the pump-housing) the system will shut down. This malfunction can be caused by a lack of liquid in one of the reservoirs or a kink in the liquid tubes for example. This malfunction can be solved by refilling the reservoirs. You can do this by removing the plugs on top of the Slimline and refilling the reservoirs with cooling fluid (***see chapter: Filling***).

FILTERS

There are filters mounted in the inlet connectors [4] & [8], they prevent contamination from getting into the system components. Remove the liquid couplings to get access to the filter. The filter can be removed by hand or with small pliers.

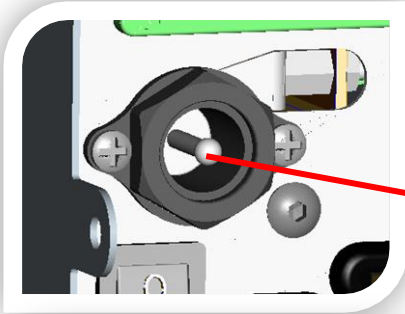

Remove the filter

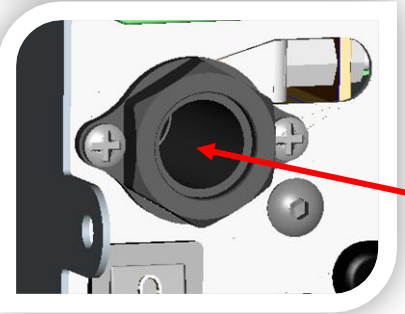
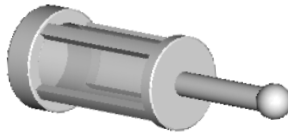

Replace the filter

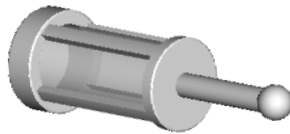

Replacing the filter (Top-Cool article number: 1106000549001)

SAFETY FUSE

For extra safety reasons the internal electric components and fan connections of the Slimline are provided with a safety fuse. This fuse will prevent the system components from getting damaged. This fuse can manually be replaced if necessary. We advise to use combination pliers for removing the safety fuse when it has to be replaced.



needle-nose pliers

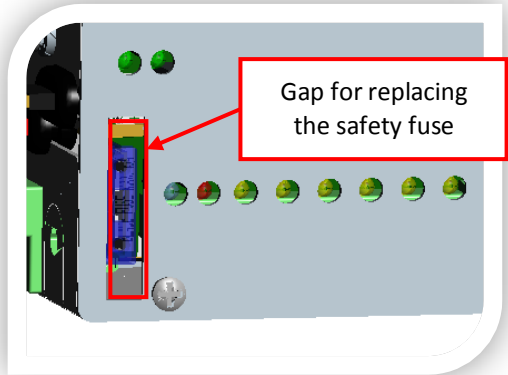

SYSTEM CONTROL LED'S

All safety controllers are connected to LED's that show whether the system is working properly or not. When the Slimline works properly all yellow LED's will light up. When the system is not working properly the LED's will show what is causing the error. There are nine LED's on the interface that give information about the Slimline. These LED's are:

1. Level switch interior (yellow)
2. Level switch exterior (yellow)
3. Flow switch interior (yellow)
4. Flow switch exterior (yellow)
5. Temperature limiter interior (yellow)
6. Temperature limiter exterior (yellow)
7. Heating (red)
8. Cooling (blue)
9. On/off (green)
10. Voltage (green)
11. Safety fuse

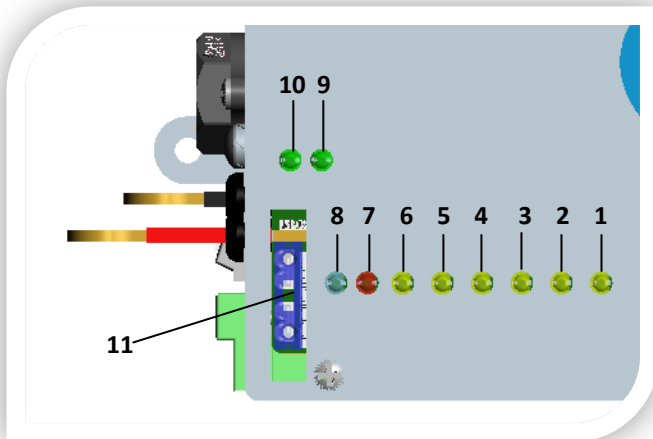

Safety control LED's

TROUBLESHOOTING



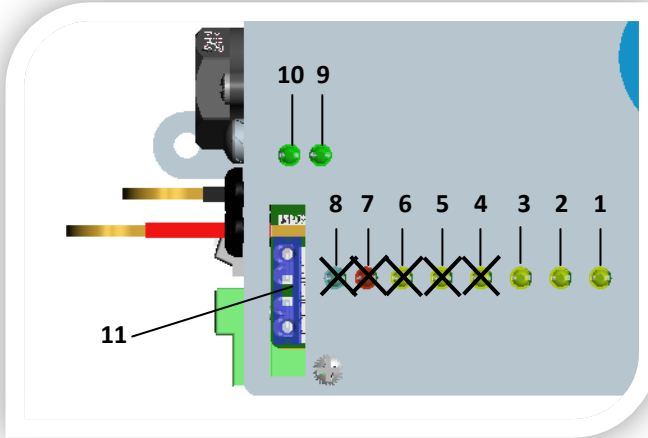









The LED's are used for detecting the reason for possible failure of the Slimline system.



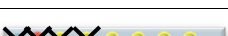

Error tracing

If there is an error, the LED that is connected to the specific safety controller will shut down. Because the LED's are connected serial all LED's after the one that is causing the error will shut down too. The first LED in row (from right) that is not working, is the one that is causing the error. In the example above we can conclude that the error occurred in the exterior flow (LED 4). Normally all LED's (except the red when cooling and blue when heating) must continuous light up.

Please try the following instructions before calling for service:

States	Possible cause	Instruction
	The Slimline is not switched on	Use the on/off switch to turn the system on
	Level low interior	Fill the interior reservoir
	Level low exterior	Fill the exterior reservoir
	Level low exterior	Fill the exterior reservoir
	Level low interior (when using process water in interior loop)	This is normal, do not take any actions
	Level low exterior (when using process water in exterior loop)	This is normal, do not take any actions
	No flow interior	Clean the filter or decrease the flow resistance
	No flow exterior	Clean the filter or decrease the flow resistance
	The interior temperature is to high	Wait until the cooling unit has cooled down to ca. 35°C and improve the heat expel of the EEM
	The exterior temperature is to high	Wait until the cooling unit has cooled down to ca. 35°C and improve the heat expel of the EEM
	The Slimline is cooling passive	Switch the Heating/Cooling switch to heating or cooling
	The set temperature (controller) is reached	Adjust the set temperature of the temperature controller if necessary

	<p>The temperature controller is not programmed to start heating/cooling</p>	<p>Adjust the controller to start heating/cooling</p>
	<p>All LED's light up (all yellow + blue and red)</p>	<p>Turn the heating/cooling switch of the Slimline off. (can only occur when using an external, optional, heating/cooling)</p>
<p>The Slimline is not heating/cooling correctly</p>	<p>There is not sufficient heat expel</p>	<p>Try a better performing IEM/EEM</p>
	<p>Not enough flow</p>	<p>Decrease the flow resistance in the liquid loops</p>
	<p>Power capacity shortage</p>	<p>Check the applied voltage and current</p>
	<p>Wrong setting of temperature controller</p>	<p>Check if the temperature controller is programmed correctly</p>
<p>The Slimline is not heating/cooling at all</p>	<p>There is a malfunction</p>	<p>Check all reasons described above that can cause the malfunction</p>
	<p>No electric power</p>	<p>Inspect the power supply</p>
	<p>Wrong wiring</p>	<p>Inspect the wiring (see chapter "electrical installation instructions")</p>



SAFETY INSTRUCTIONS

1. Before making any modifications in your system, turn off the electric power and disconnect the main connections of the system.
2. Always follow the instructions and regulations conform this manual or stricter local regulations if they apply.



TIPS

1. If any doubts occur on how to use the Slimline otherwise as listed in this manual, contact Top-Cool for instructions or confirmation.
2. If there is doubt about a (sufficient) flow, you can use a flow switch, a flow meter or flow indicator (like a propeller) in the flow to visually check if there is still a flow in the system.
3. You can use the Slimline for cooling but also for heating as main operating purpose!
4. For a better performance of the Slimline it is recommended to cover the tubes between the Slimline and the IEM combination with insulation foam. It is also recommended using tubes that are as short as possible to reduce loss of thermal energy.
5. Make sure there are no kinks in the liquid tubes that can block the liquid flow.
6. To reach a high efficiency the temperature of the cooling fluid that is leaving the EEM should maximum be 10°C above the ambient temperature.

TECHNICAL DATA
DIMENSIONS

Slimline	Dimensions (mm)	Dimensions (in)
SL-XXX-XX-TCT4-12	152 x 395 x 56	5,98 x 15,55 x 2,20
SLW-XXX-XX-TCT4-230-C	152 x 395 x 106	5,98 x 15,15 x 4,17
SLW-XXX-XX-TCT8-24-C	152 x 395 x 100	5,98 x 15,15 x 3,93
SLW-XXX-XX-TCT8-230	152 x 395 x 150	5,98 x 15,55 x 5,90

TECHNICAL SPECIFICATIONS

	Water (°C)	MEG -10 (°C)	MPG -10 (°C)
Storage temperature (when filled)	5 till 50°C	-5 till 50°C	-5 till 50°C

Optional components	
EEM	Exterior Exchange Module
IEM	Interior Exchange Module
KEI	Kit Electric Installation
KMI	Kit Mechanical Installation
KC	Kit Connectors
CBT	Control Board Temperature
CBR	Control Board Remote

MISCELLANEOUS

MARKS USED



Caution: read these chapters very carefully, the information given is very important for safety, installation and operating. If these points are not followed strictly or there is doubt that they are not met, Top-Cool doesn't support or give warranty whatsoever.



Important information: actions to be taken concerning the electric wiring and power (you will need electrical equipment).



Important information: action to be taken concerning installation of the Slimline and maintenance to the total system (you will need tools to complete these actions).



Important tips: these tips are very useful on how to install or to use the system based on years of experience to maintain thermal performance.

ENVIRONMENTAL

For disposal of any damaged or used Slimline, dispose accordance local regulations.

CERTIFICATIONS

Slimline system components certifications to be defined

The internal **TCT-unit** is in conformity with the following guidelines:



CE, declaration of conformity

The product is in conformity with the essential requirements of the applicable EC directives.

NEN-EN-IEC 60079-14
NEN-EN-IEC 60079-15
NEN-EN-IEC 60529



ATEX directive

This equipment is suitable for operating in potential explosive atmospheres (zone 2 and zone 22, potential gas and dust explosions).

According to the requirements of the Directive: ATEX Directive 94/9/EG.

The products are in conformity with ATEX under the following guidelines:

Ex II, 3 G/D, EexnC, IIC, T6, IP54 (Standard version)

Ex II, 3 G/D, EexnC, IIC, T6, IP67 (Sealed version)



IP-classification (International Protection)

IP54: protection against dust and splash proof.

IP67: dust-tight and protection against submersion for 30 minutes long.



Mechanical impact

The unit has undergone vertical drop tests, from 2 meters in vertical and horizontal orientation with maximum impact to solid ground, and successfully passed.



RoHS

The TCT-unit does not contain any of the 'restriction of hazardous substances' (RoHS) listed substances.



Common used materials for food applications

The parts of the unit contains the following common used materials in food applications:

- Polypropylene (PP)
- Ceramic material
- Thermoplastic elastomers (TPE)
- Stainless steel fasteners

STORAGE AND TRANSPORT

The Slimline can be transported in any orientation when the system is not filled. Only a completely empty system is allowed to be stored under 0°C.

DISCLAIMER AND WARRANTY

DISCLAIMER

This manual should be kept in a safe place for handy reference. All efforts have been made to provide the most comprehensive manual possible, though everything without prejudice. Top-Cool is never responsible for any kind of damage to persons, products, systems, the module itself or whatsoever due to the Device. Top-Cool assumes no liability expressed or implied for any damage(s) occurring to any component as result of using products of Top-Cool. The user or purchaser of this product will confirm to the general Terms of Delivery of Top-Cool.

WARRANTY

A Slimline module is guaranteed for 12 months from the date of purchase. The purchaser should register the Slimline within 30 days after purchase with Top-Cool to ensure warranty. During the warranty period, warranty is given to the module for defects in material and workmanship, under condition that:

1. All the precautions, installation, operation and security instructions are strictly followed.
2. The module does not show any signs of damage as a result of not following instructions, handling or negligence.
3. The module does not show any sign of modifications, demounts, adjustments or whatsoever.
4. All labels are present, unaffected and clearly readable.
5. The module does not show any signs of excessive wear.
6. The user can show the original invoice with date and place of purchase.

Normal wear is excluded from warranty.

After receiving the unit, the RMA report and original invoice, Top-Cool will examine if warranty is applicable. Only when warranty is applicable Top-Cool is obliged to repair/replace components or replace the whole module, with the same or nearest equivalent. Top-Cool reserves the right to reject or determine the RMA-procedure when warranty is void.

The installation and operating instructions reflect the current technical specifications at time of print. We reserve the right to change any specifications or notes to this manual or described products without notice. Nothing of this manual may be exposed, copied, made public or distributed



Inventors of the Top-Cool Technology

Top-Cool Products B.V.

Groesweg 37B

Maasbree

The Netherlands

Tel. +31 -77 - 465 01 42

Fax +31 -77 - 465 01 43

Web: www.top-cool.eu

Email: info@top-cool.eu