

Datasheet TCT4 PP 07

This cooling engine from the Power-Pack series has 4 Peltier elements working together for producing a top level cooling performance for many applications.

The 2 liquid circuits have patented direct surface contact with the Peltier elements. Together with the internal turbulators they create an optimal heat transfer from the element to the water to create maximum cooling performance.

Dimensions: 160 x 125 x 40 mm
Tube connections: Ø12 mm
Weight: 475 grams
Max. test pressure: 2 Bar

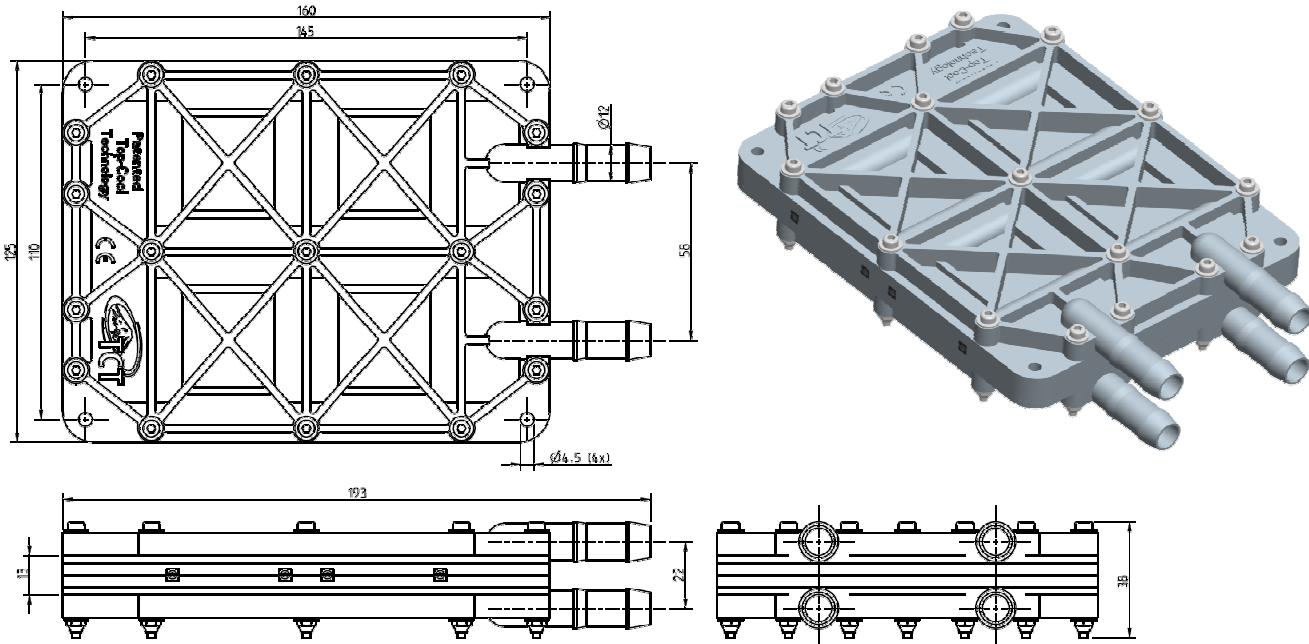

Peltier elements:

Number: 4
 Type: 15,6 V / 7 A

Electrical connections:	Voltage:	Power consumption	Max. Cooling power	Max. COP (η)
A. 4 TECs parallel	0 V– 15,6 V	280 Watt (12V)	280 Watt	100%
B. 2 TECs parallel, 2 serial	0 V– 15,6 V	175 Watt (12V)	210 Watt	120%
C. 2 TECs serial + 2 TECs serial	0 V– 24 V	70 Watt (12V)	140 Watt	200%
D. 4 TECs serial	0 V– 24 V	20 Watt (12V)	55 Watt	270%

