

Slimline

Datasheet
SL-180-11-TCT4-12 [1106090909001]

The Slimline is a multi applicable thermal system that can be used as a cooling and or heating device for many different applications. Never was integrating cooling features so easy, thanks to the plug-and-play functionality of this new modular low pressure water circulating electric cooling system with integrated liquid pumps, sensors and controllers. This advanced cooling and heating system utilises a patented Peltier technology with the use of standard TCT-units from the renowned and entrusted PowerPack-series.

Specifications: SL-180-11-TCT4-12 [1106090909001]

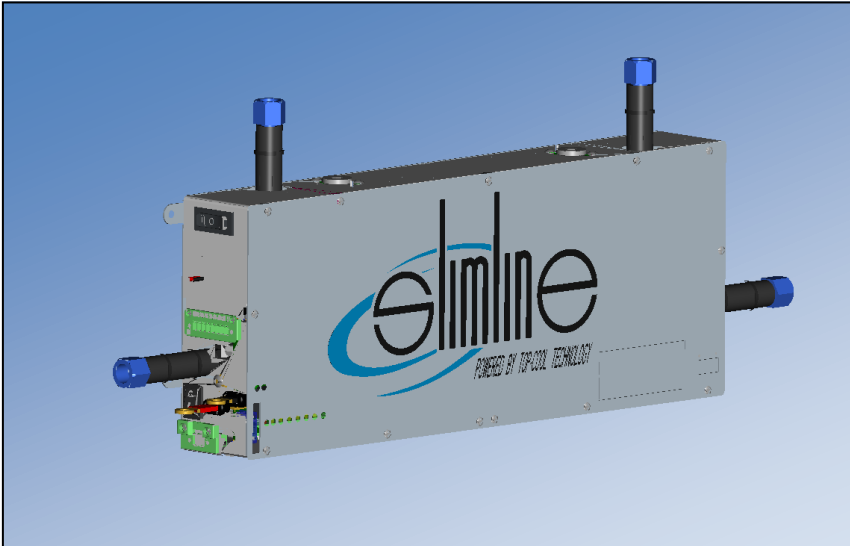

- ✓ Cooling and heating
- ✓ Active and passive cooling
- ✓ Compact and lightweight
- ✓ High performance
- ✓ Durability & Reliability
- ✓ No CFC's, No HFC's
- ✓ Water as cooling liquid
- ✓ Shock proof
- ✓ Freedom of heat expel
- ✓ Silent operating
- ✓ Accurate temperature control
- ✓ Environmental friendly
- ✓ Easy mounting
- ✓ Discretionary operating
- ✓ Stationary cooling engine
- ✓ Multi applicable
- ✓ Plug and play

Number of TCT-units:	1	
Type of peltier elements:	15V 10A	4P
Main connection (Electric power max.)	12VDC 40A	Incl. power fan connections
Electric power (without fans)	12VDC 34A	400W
Main dimensions Slimline (h x w x d)	152 x 395 x 56 mm	5.98 x 15.55 x 2.20 in
Couplings (inlet & outlet)	1/4" female BSP	4X
Weight	2,3 kg (unfilled)	2,5 kg (filled)
Max. Test pressure	1,0 bar	14,5 PSI
Cooling liquid	Water, MEG, MPG	
Integrated pumps	2X	F10H6

Performance

Operating voltage	10VDC - 14VDC	
Advised operating voltage	12VDC	
Heating power	400W	
Heating power HPE (Heat Pump Effect)	800W	
Cooling power at T interior = T max = 55°C	400W	
Cooling power at T interior = T ambient = 20°C (200 W/°C exterior expel)	190W	
T interior minimum. (200 W/°C exterior expel)	-12°C	10,4°F
T interior minimum. (90 W/°C exterior expel)	-11°C	12,2°F
T interior minimum. (60 W/°C exterior expel)	-9°C	15,8°F
T interior minimum. (30 W/°C exterior expel)	-7°C	19,4°F
Noise level	<20	dBA

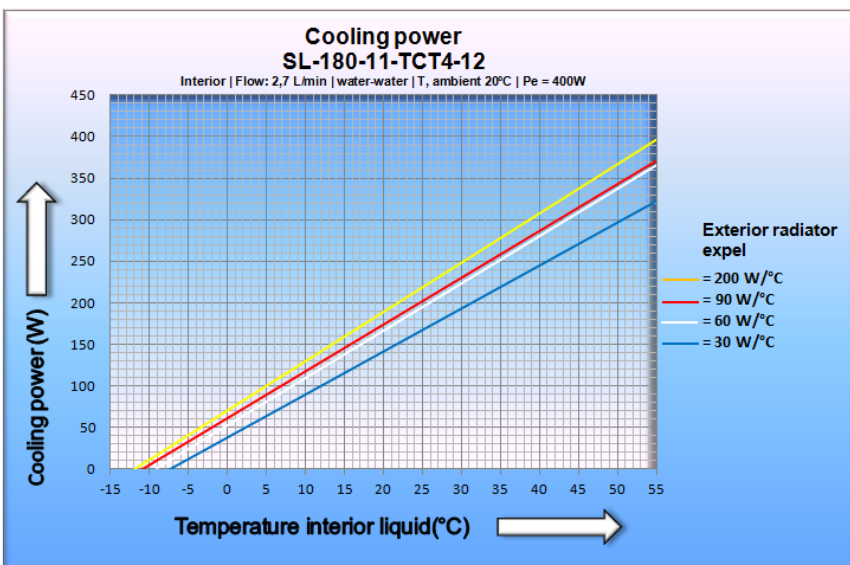

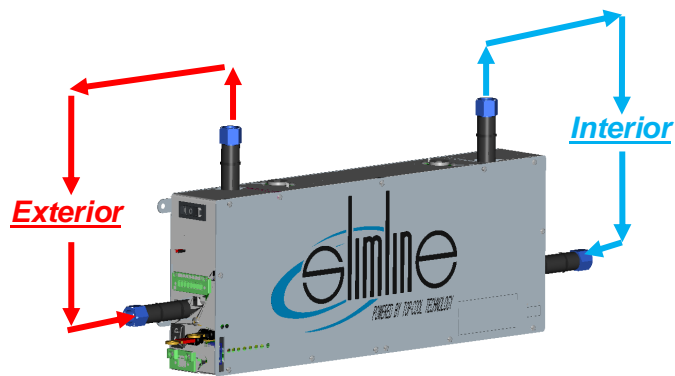
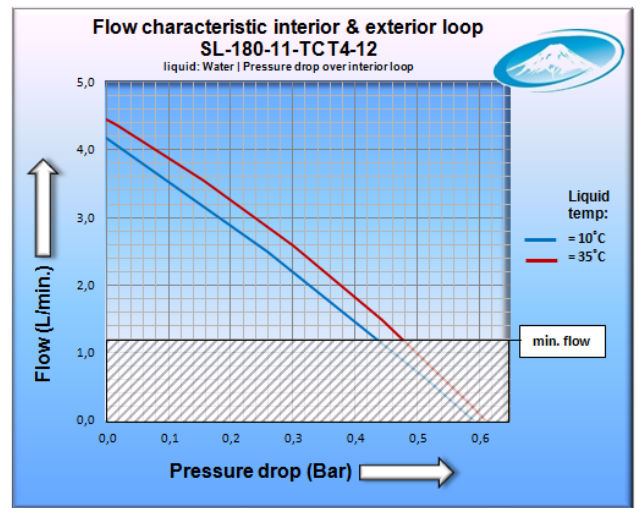
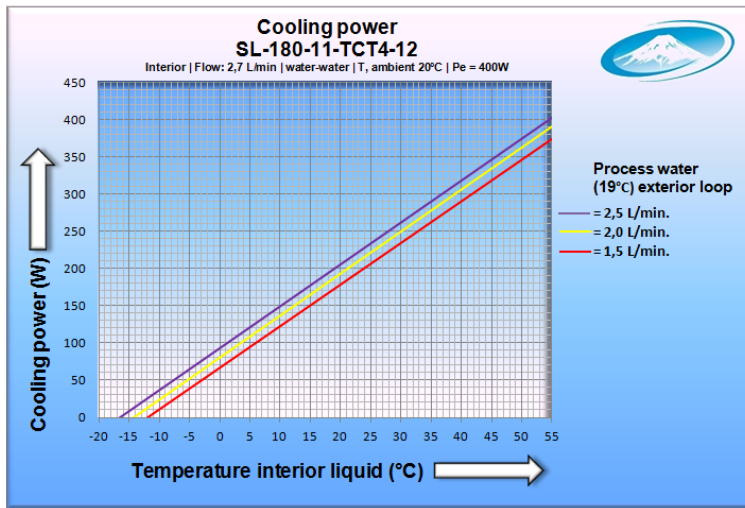

Dimensions

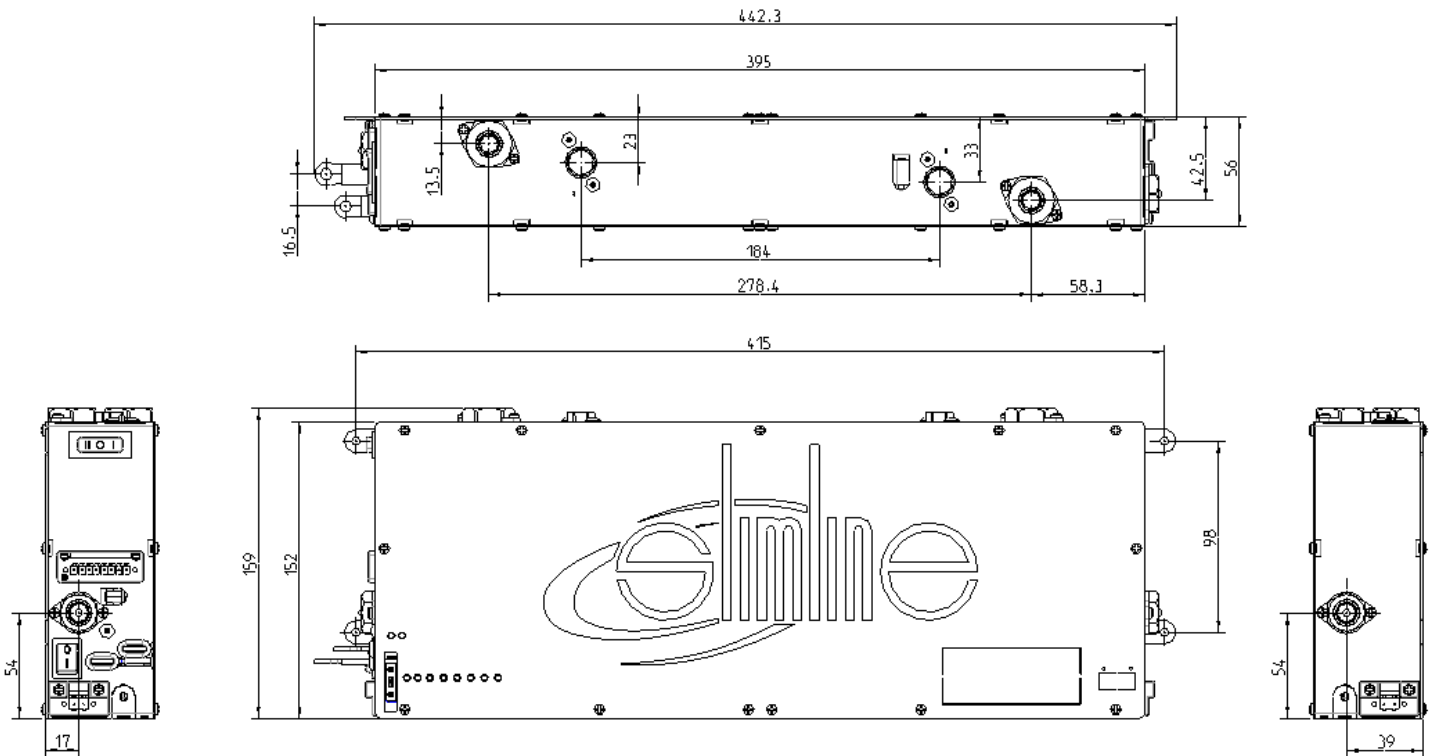

Example of a Slimline cooling system

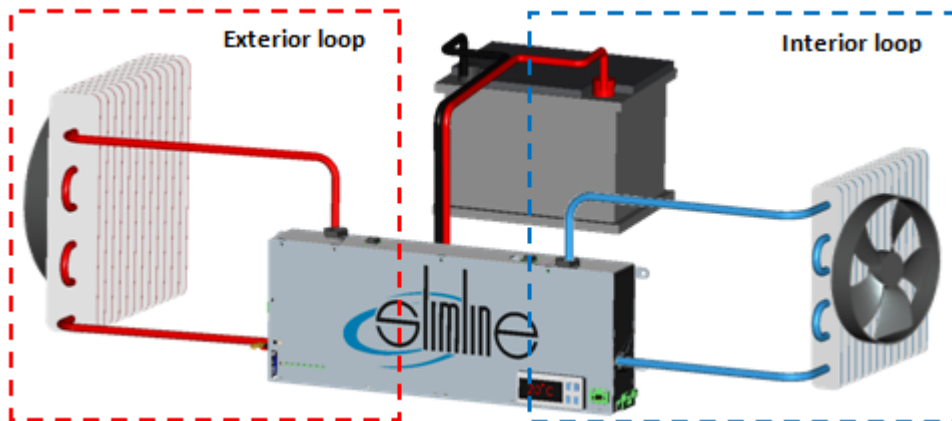

Installation	
Main connection electric	M6 cable lugs
Housing material	Aluminium
Interior reservoir content	80 ml
Exterior reservoir content	80 ml
Safety fuse	15A
Control board 1, 2, 3, 4, 5 & 8	Signal wires
Control board 6(+), 7(-)	12VDC 0,5A
Fan connection interior	12VDC 3A (max.)
Fan connection exterior	12VDC 3A (max.)
Distance between mounting Lugs horizontal (wall mount)	415 mm
Distance between mounting Lugs vertical (wall mount)	98 mm
Distance between mounting Lugs horizontal (bottom mount)	413 mm

